



# INSTRUCTIONS

-J03332

2006-08-30

## ONE AND ONE-HALF INCH OIL TEMPERATURE GAUGE KIT

### GENERAL

#### Kit Number

74513-04

#### Models

For model fitment information, please see the P&A Retail Catalog or the Parts and Accessories section of [www.harley-davidson.com](http://www.harley-davidson.com) (English only).

#### Additional Parts Required

Installation of this kit will require the following special tools, additional parts, and miscellaneous supplies which are available from a Harley-Davidson dealer.

- Butt Splice Connector (70586-93)
- Gauge Housing Kit - Each 1.5 inch gauge will require an additional Gauge Housing Kit to complete installation.
- Loctite<sup>®</sup> Thread Sealant 565 (99818-97)
- Packard Crimp Tool (HD-38125-8)
- Ultra-Torch (HD-39969)

Model specific requirements include:

**2007-later Touring models:** Require the additional purchase of Adapter Kit 26133-07.

2007-later Touring models using Premium Oil Cooler 26155-07:

- Install Oil Cooler following instructions supplied with that kit.
- Install Sensor as specified in Adapter Kit 26133-07.

**Softail models:** Oil Line Remover/Retainer Installer (HD-44455), O-rings (63101-00), and Oil Line (26408-04).

**Dyna and FLHR models:** The original hose cover will not fit however, optional transmission interface covers can be used to conceal the hose fittings. Select from the offerings available in the Genuine Motor Accessories and Genuine Motor Parts catalog.

**Road King kits:** 66503-02, 66503-00, 66530-03, 66069-02, and 66003-99.

**Dyna kits:** 66018-99, 66038-99, and 66515-00.

#### ▲ WARNING

**Rider and passenger safety depend upon the correct installation of this kit. If the procedure is not within your capabilities or you do not have the correct tools, have a Harley-Davidson dealer perform the installation. Improper installation of this kit could result in death or serious injury. (00308b)**

#### NOTE

*This instruction sheet references Service Manual information. A Service Manual for your model motorcycle is required for this installation and is available from a Harley-Davidson dealer.*

#### NOTICE

**It is possible to overload your vehicle's charging system by adding too many electrical accessories. If the combined electrical accessories operating at any one time consume more electrical current than the vehicle's charging system can produce, the electrical consumption can discharge the battery and cause damage to the vehicle's electrical system. See an authorized Harley-Davidson dealer for advice about the amount of current consumed by additional electrical accessories or for necessary wiring changes. (00211c)**

#### ▲ WARNING

**When installing any electrical accessory, be certain not to exceed the maximum amperage rating of the fuse or circuit breaker protecting the affected circuit being modified. Exceeding the maximum amperage can lead to electrical failures, which could result in death or serious injury. (00310a)**

#### NOTE

*This kit requires up to 65 milliamps additional current from the electrical system.*

### Kit Contents

See Figure 17 and Table 1.

### INSTALLATION

#### Prepare Motorcycle

#### ▲ WARNING

**To prevent spray of fuel, purge system of high-pressure fuel before supply line is disconnected. Gasoline is extremely flammable and highly explosive, which could result in death or serious injury. (00275a)**

1. **EFI models:** Purge fuel supply of high pressure gasoline and remove fuel supply line following the instructions in the Service Manual.
2. Remove oil drain plug, drain engine oil, and remove oil filter following the instructions in the Service Manual.
3. Install oil drain plug.
  - a. Inspect O-ring for tears or damage. Replace if required. Wipe oil/debris from plug.
  - b. Install O-ring and drain plug. Tighten to the torque specification found in the Service Manual.

- c. **2007-later models:** Install adapter following the instructions in kit 26133-07.

**NOTE**

Do not use the oil filter wrench to tighten the oil filter.

- Clean the oil filter mount of gasket material. Lube the gasket on a new oil filter with engine oil and install the new filter. Hand tighten oil filter 1/2 to 3/4 turn after gasket contacts filter mounting surface.
- Remove seat and side covers following the instructions in the Service Manual.

**▲ WARNING**

To prevent accidental vehicle start-up, which could cause death or serious injury, disconnect negative (-) battery cable before proceeding. (00048a)

- Disconnect negative (-) battery cable from the battery.

**▲ WARNING**

Gasoline can drain from the carburetor fuel line when disconnected from fuel valve fitting. Gasoline is extremely flammable and highly explosive, which could result in death or serious injury. Wipe up spilled fuel immediately and dispose of rags in a suitable manner. (00256a)

- Carbureted models:** Turn the fuel supply valve to OFF. Remove the fuel line from the valve.

**NOTE**

Up to three 1.5 inch gauges may be installed in a single gauge cluster bracket. Follow the instructions sheets found in the additional gauge kits to prepare the motorcycle. Continue to follow the instructions thru routing the wire harness, installing the gauges, wiring the power, sensor and ground leads, returning the motorcycle to service and testing the operation of each gauge.

- Remove fuel tank following the instructions in the Service Manual.

## Install Oil Temperature Sending Unit

### Softail Models

- Coat oil temperature sending unit with Loctite Thread Sealant 565 and install sending unit into fitting.

**NOTE**

When mating the fitting to the supply hose, the sending unit and clamps should always be positioned so that it does not chafe or rub on any other components.

- See Figure 1. Locate oil supply (feed) hose. The supply (feed) hose (1) is on the tank end of the lowest of three oil lines directly above the transmission under the oil tank on the right side.

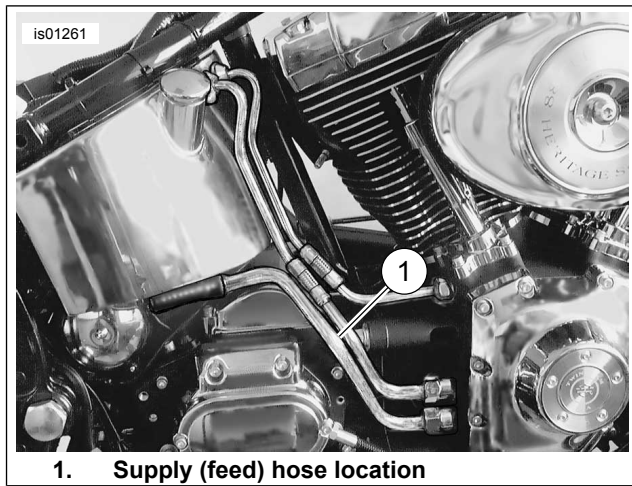

1. Supply (feed) hose location

**Figure 1. Softail Supply (Feed) Hose**

- Remove any plastic separation brackets between supply hose and return hose.
- Cut hose clamp around rubber line and metal feed line at oil tank.
- Pull metal inlet feed oil line from engine at engine fitting.
- Remove retainer, O-rings, and spacer using Oil Line Remover/Retainer Installer Tool. Discard O-rings and retainer.
- Insert tool with new retainer, spacer, and new O-rings (63101-00) with oil line (26408-04) into engine fitting until tabs on retainer lock into place. Remove tool.
- Remove hose on oil tank inlet feed tube.
- See Figure 17. Cut hose (13) from kit into 2 equal lengths and fit on to opposite ends of fitting. Secure both sides of T-fitting with worm gear clamps (11).
- Orient sending unit to point under the oil tank and across the frame and slide feed oil line with worm gear clamp on to T-fitting and sensor hose.
- Slide fitting hose end with worm gear clamp onto the oil tank tube and press metal feed line into engine fitting.
- Tighten worm gear clamps.

### Dyna and FLHR Models

**NOTE**

2007-later Road King models: Install oil temperature sensor in adapter assembly following the instructions in kit 26133-07. Then skip to "Route Wire Harness" subtopic.

- Coat oil temperature sending unit with Loctite Thread Sealant 565 and install sending unit into fitting.

**NOTE**

When mating the fitting to the supply hose, the sending unit and clamps should always be positioned so that it does not chafe or rub on any other components.

2. See Figure 2. Locate the oil supply (feed) hose. Remove the right side oil line cover (1) between the transmission and the engine case. The supply (feed) hose is the lower line into the engine case.

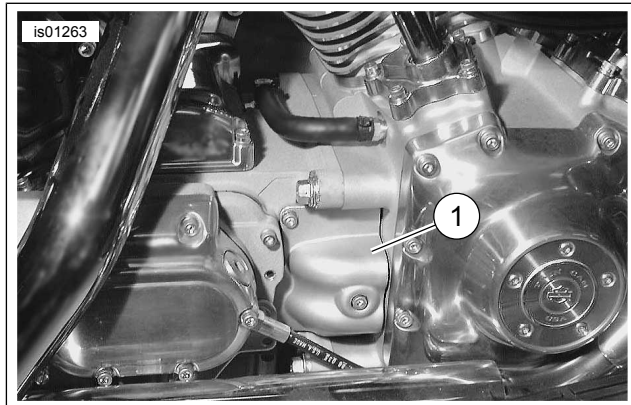

**Figure 2. Dyna/FLHR Oil Line (Located Under Cover)**

3. See Figure 17 and Figure 5. Fit the 90° fitting (14) and sending unit (17) to the supply (feed) hose ( Figure 5, Item 1).
4. Cut and remove supply (feed) clamps and discard hose.
5. Using hose (13) from kit, cut and fit 1-1/2 in. (38.1 mm) segment to one end of 90° fitting and 1-1/2 in. (38.1 mm) segment with worm gear clamp (11) to other end.
6. Using worm gear clamps, install one segment on the case side with the sending unit angled up and under the return line.
7. If 90° fitting does not appear to line with corresponding pipe nipple on crankcase (front), remove transmission side nipple (back), clean off threads to remove any build up of pipe fitting sealer, and install after applying Loctite Thread Sealant 565 to threads. Do not overtighten fitting. See Service Manual for torque value of fitting.
8. Tighten worm gear clamps.

#### **XL Models**

1. Coat oil temperature sending unit with Loctite Thread Sealant 565 and install sending unit into fitting.

#### **NOTE**

*When mating the fitting to the supply hose, the sending unit and clamps should always be positioned so that it does not chafe or rub on any other components.*

2. Locate oil supply (feed) hose. **2004-later XL models:** See Figure 3. The supply (feed) hose (1) is the lower of three hoses running along side the crankcase covers on the right side. **2000-2003 XL models:** See Figure 4. The supply (feed) hose (1) is located on the back side of the oil tank when viewed from the right side of the motorcycle.

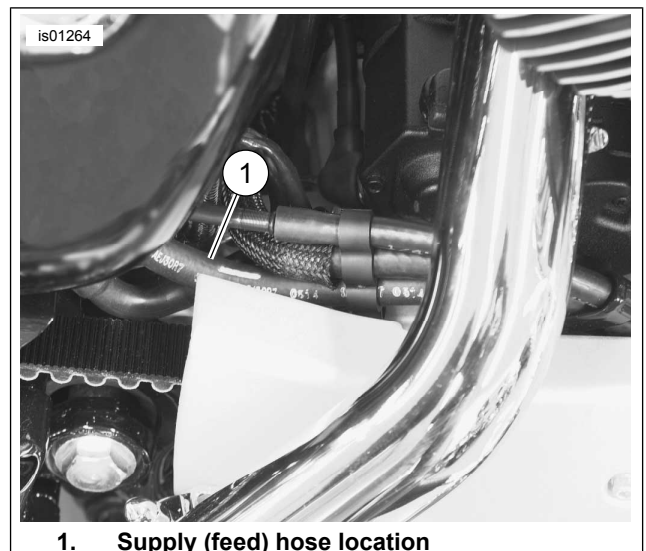

**1. Supply (feed) hose location**

**Figure 3. XL Supply (Feed) Oil Hose (2004 Custom)**

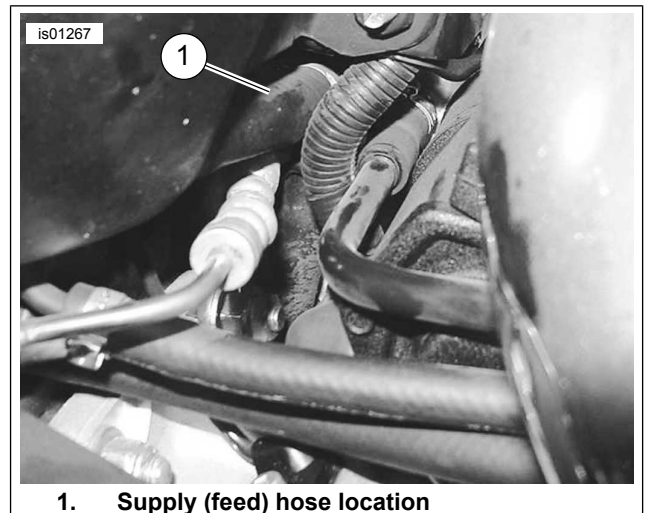

**1. Supply (feed) hose location**

**Figure 4. XL Supply (Feed) Oil Hose (2000-03 Custom)**

3. See Figure 17 and Figure 6. Fit the T-fitting (15) and sending unit (17) ( Figure 6, Item 1) to the supply (feed) hose.
4. Remove any plastic separation brackets between the supply hose and the return hose.
5. Make one cut in the supply hose:
  - a. **2003-earlier:** 1.5 in. (38.1 mm) from the edge of the oil tank.
  - b. **2004-later:** 3 in. (76.2 mm) from the oil tank end of the hose.
6. Push ends of hose with worm gear clamps (11) onto T-fitting and sending unit.
  - a. **2003-earlier:** Orient sending unit to face forward at an angle.
  - b. **2004-later:** Orient sending unit to point up.
7. Tighten worm gear clamps to seal the line.

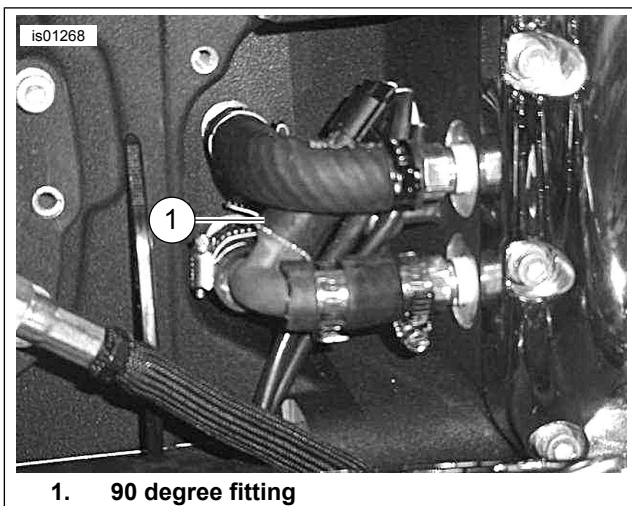

1. 90 degree fitting

Figure 5. Dyna and FLHR Sending Unit

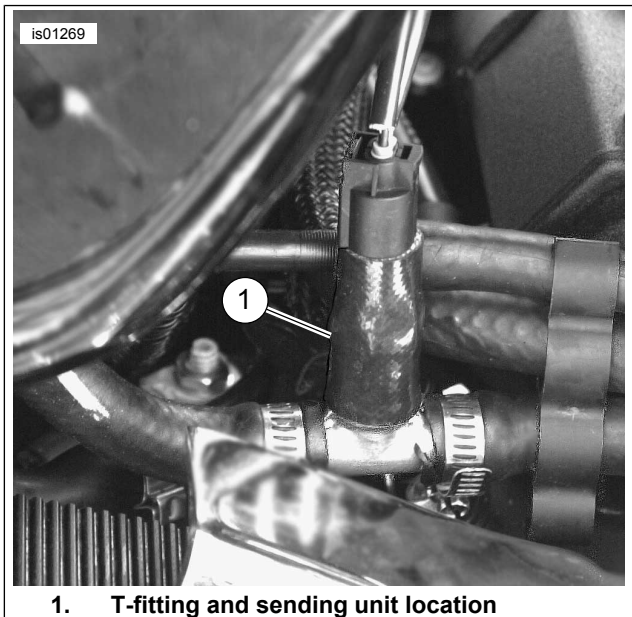

1. T-fitting and sending unit location

Figure 6. 2004 XL Sending Unit

## Install Bracket Kit and Oil Temperature Gauge

1. Install oil temperature gauge following the instructions in the bracket kit.
2. Fit perimeter groove in rubber isolation gasket (7) to inside edge of bracket, and tab of isolation gasket to square cutout in bracket.
3. Rotate oil temperature gauge (8) to align the face legend horizontal to the rider and push in the gauge. The locating tab on gauge will align with locating notch in gasket.

### NOTE

Lubricating the gasket with soap and water will make installation of the gasket and the gauge easier.

## Route Wire Harness

### NOTE

Before shortening the wire harness by trimming the sensor, ground or the power wire, route the wire harness to all three locations and adjust as necessary to achieve a tight but flexible arrangement.

1. See Figure 17. Route wire harness conduit (10) along frame backbone and up through upper triple clamp to bracket. **2007-later Road King models:** Route signal leads back towards front of vehicle and down left frame downtube. Secure with cable straps. Any excess wire harness should be coiled and secured under fuel tank with cable straps.
2. Locate the ground terminal and route the black ground lead to the ground location for the model motorcycle. Refer to Service Manual for instructions. **2004-later Softail:** See Figure 7. On the frame strap (1) under the seat directly in front of the battery. **2000-2003 Softail:** Top of the frame under the seat toward the front. **2004-later Dyna:** See Figure 8. At either of the rear ground studs (1,2) under the fuse block. **2000-2003 Dyna:** On top of the frame under the seat toward the tank. **2004-later FLHR/I:** See Figure 9. Under seat directly in front of battery (1). **2000-2003 FLHR/I:** In the well underneath the seat under the circuit breaker. **2000-2003 XL:** The wire harness ground screws can be in several locations including under the seat at the junction of the frame backbone and the extensions for the shock mounts, on the left side of the frame under the tank, or on the left side of frame near the swing arm. **2004-later XL:** On the backside of the primary case at the rear of the engine.

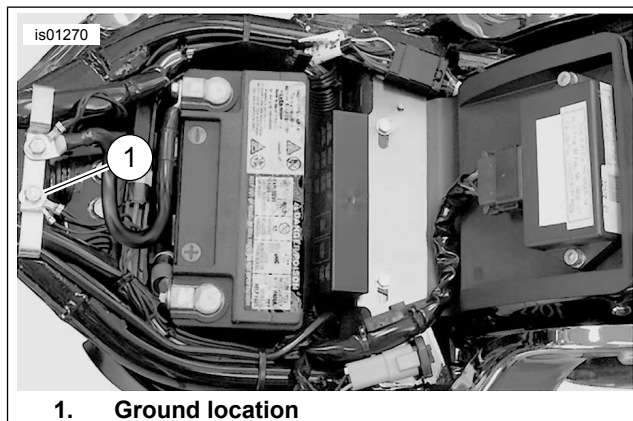

1. Ground location

Figure 7. 2004 Softail Ground

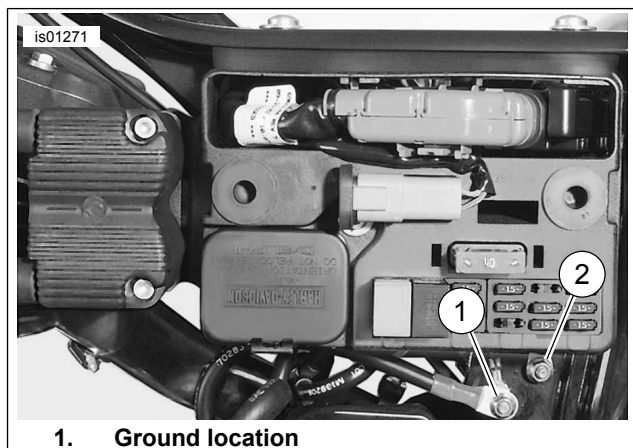

1. Ground location

Figure 8. 2004 and Later Dyna Ground

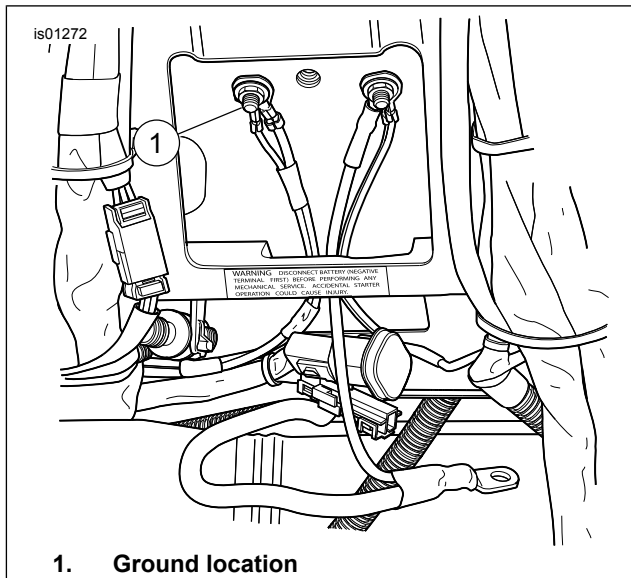

Figure 9. 2004 FLHR Ground

1. Route the orange/white power lead lead underneath and down a rear frame rail to the power location for the year and model. **2004-later Softails:** The fuse block under the seat behind the battery will be fitted with an adapter to the fuse socket labeled P&A IGN to provide a main harness power lead. **2000-2003 Softails:** Locate the orange/white power lead in the tail lamp harness pin connector (7A) under the seat behind the right rear corner of the battery. **2004-later Dyna:** The fuse block inside the left side cover will be fitted with an adapter to the fuse socket labeled OPEN to provide a main harness power lead. **1999-2003 Dyna:** Locate the orange/white power lead in the tail lamp harness pin connector (7A) under the seat. **2004-later FLHR:** The fuse block will be fitted with an adapter to the fuse socket labeled P&A IGN to provide a main harness orange/white power lead. **1999-2003 FLHR:** A main harness orange/white power lead inside the right side cover near the top. **2004-later XL:** Behind the left side cover, locate the orange/white power lead from the main harness to the diagnostic pin connector (91A). **2000-2003 XL:** See Figure 10. A main harness orange/white power lead (1) inside the side cover or under the seat to power the gauge.

**NOTE**

On some XL models the ignition module must be removed to access the orange/white power lead.

2. Route oil temperature signal leads and connector down along frame downtube to oil temperature sending unit.
3. Verify the position and length of the wire harness and the wire leads to the sending unit, the power source and to the ground.
4. Bundle the oil temperature harness to the main wiring harness and any additional gauge harness along frame backbone by using cable straps (12) to support wires so they do not chafe or contact hot or moving points.
5. Slide the segment of high temperature tubing (16) over the connector and mate the sealed connector on the end of the oil temperature lead to the sending unit. **Dyna and 2006-earlier Touring:** With the new kit installed, the right side oil line cover will not fit and can be left off the motorcycle.

**Wire the Ground**

1. When the correct length of ground wire has been established, cut the harness ground wire as necessary.
2. Strip 3/8 in. of insulation from end of ground wire.

3. **1999-2003 Dyna:** See Figure 17. Crimp 5/16 in. ring terminal (2) to ground wire. **All other Dyna models:** See Figure 17. Crimp 1/4 in. ring terminal (3) to ground wire.
4. Remove ground wire fastener and add ring terminal to stud.
5. Install ground fastener and tighten to the torque specification found in the Service Manual.

**Adapt Fuse Block to Power Lead**

1. **2004 models except XL:** Access fuse block and remove fuse block cover. **2007-later models:** Fuse block cavity marked P&A IGN is located on right side of vehicle. See Figure 7. The fuse block connector terminal uses the "spring tab" type connector.
2. See Figure 17 and Figure 11. Select the fuse block adapter (9) from the kit which has both the 2004 Softail/Dyna ( Figure 11, Item 1) and 2004 Road King ( Figure 11, Item 2) and cut off the end that does not fit the P&A IGN (OPEN) socket terminal on the back of the fuse block.

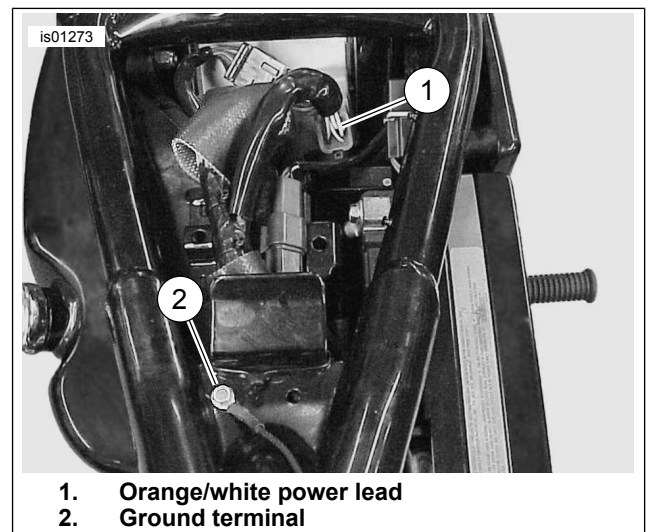

Figure 10. XL Wire Harness and Ground Location

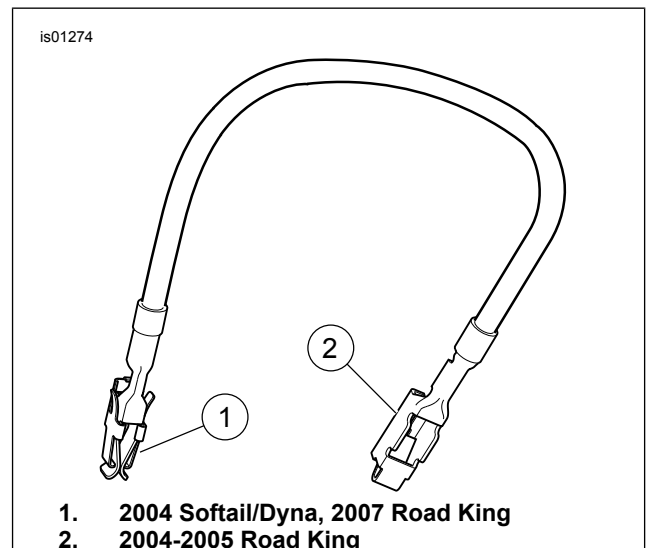
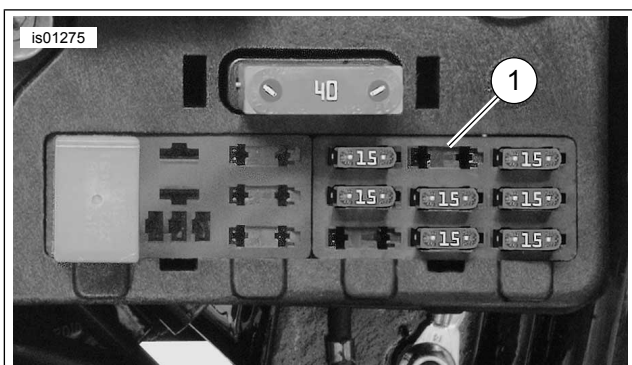

Figure 11. Fuse Block Adapter



1. Fuse socket

Figure 12. Socket for 2 Amp Fuse (2004 Dyna)

**NOTE**

There should be a wire connected to one side of this socket on the back of the fuse block, but no wire exiting the socket and no fuse in the fuse holder on the front of the fuse block.

3. Install the end of the kit adapter wire into the socket on the back of the fuse block marked as P&A IGN (OPEN).
4. See Figure 17 and Figure 12. Install a 2-Amp fuse (18) ( Figure 12, Item 1) in the P&A IGN (OPEN) slot.

### Splice Orange/White Power Lead

**NOTE**

If the installation includes more than one gauge, the orange/white power leads for the other gauge(s) will be butt spliced with the orange/white power lead and the orange/white power lead from the motorcycle ignition. Follow the instructions in any additional gauge kits to complete installation up to this procedure.

1. When the correct length of orange/white power lead from the gauge to the main harness or fuse block adapter lead has been established, cut the lead as necessary.
2. Strip 3/8 in. of insulation from ends of the orange/white leads (including if required, the fuse block adapter lead).
3. See Figure 13. Identify splice configuration required (1, 2, or 3).

**NOTE**

The butt splice connector is blue for 14-16 gauge wire.

4. See Figure 17. Insert the leads and crimp the metal insert of the butt splice (1).

**NOTE**

See Figure 14. Gently hold the butt splice from the kit in the "blue" jaws of the Packard Crimp Tool. Feed the stripped lead(s) up to the wire stop inside the metal insert (1) in one half of the connector. Squeeze the tool to crimp the metal insert (2). The tool automatically opens when finished. Repeat for the other end of the connector (2) to capture one or two stripped leads including, if required, the fuse block adapter.

**▲ WARNING**

Be sure to follow manufacturer's instructions when using the UltraTorch UT-100 or any other radiant heating device. Failure to follow manufacturer's instructions can cause a fire, which could result in death or serious injury. (00335a)

- Avoid directing the heat toward any fuel system component. Extreme heat can cause fuel ignition/explosion resulting in death or serious injury.

- Avoid directing heat toward any electrical system component other than the connectors on which heat-shrink work is being performed.
  - Always keep hands away from tool tip area and heat shrink attachment.
5. Using the Ultra-Torch or other suitable radiant heating device, heat the crimped splice from the center of the crimp out to each end until the sealant exudes out both ends of the connector (3) and the tubing assumes a smooth cylindrical appearance.

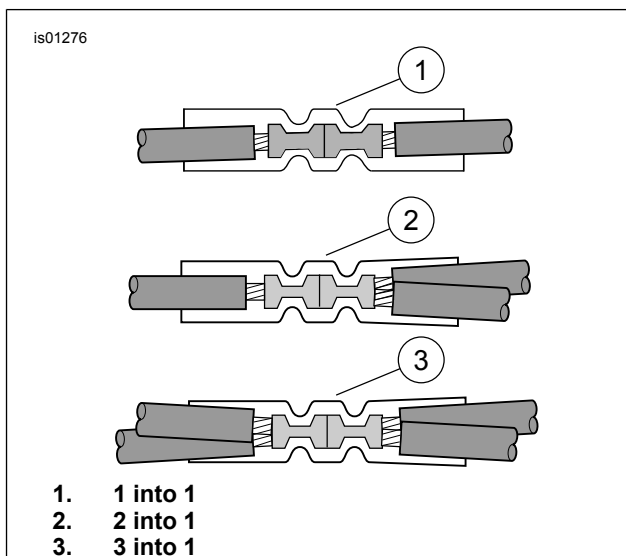

1. 1 into 1
2. 2 into 1
3. 3 into 1

Figure 13. Splice Configurations

### Wire Harness to Oil Temperature Gauge

**NOTE**

Before stripping or crimping the ring terminals on to the gauge wire leads, inspect steering clearance, suspension clearance and look for any pinch points along wire path. Turn forks lock to lock as part of inspection.

1. See Figure 17. Lubricate the conduit with soap and water and pull the wires and conduit through the housing grommet (6).
2. Strip 3/8 in. of wire from ends of orange/white power and black ground wires.
3. Crimp #6 ring terminals (5) to leads.

**NOTE**

At the gauge cluster bracket, the wire conduit for the oil temperature gauge can be identified as the wire conduit with a yellow signal lead in addition to the ground (BK) and power (O/W) lead. Conduits for additional gauges can be identified by the color of or lack of (voltmeter) the signal wire.

4. Thread standoff from gauge housing kit into bottom of gauge and tighten.

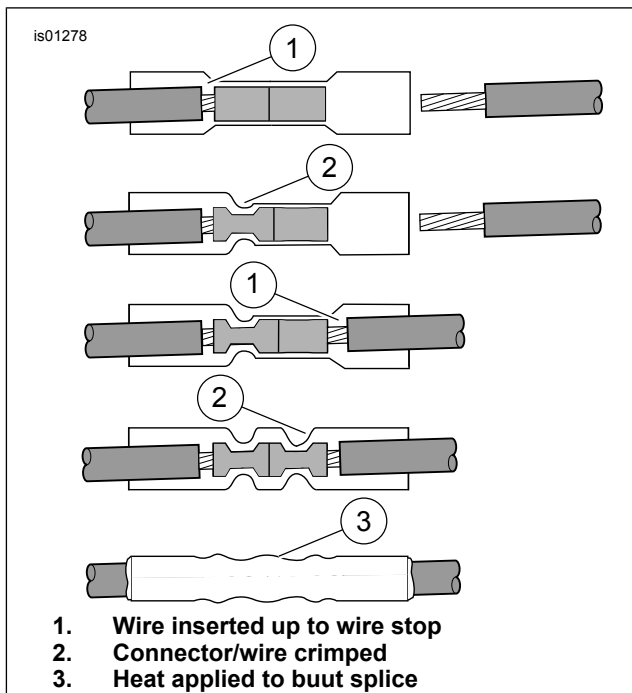

**Figure 14. Splice Sequence (1 into 1 Configuration)**

5. Thread ring terminated wires and conduit into gauge housing.
6. Fit the grommet to the housing.
7. Match wire colors to terminal posts on back of oil temperature gauge:
  - a. Orange/white (power) to positive (+) terminal.
  - b. Black (ground) to negative (-) terminal.

**NOTE**

See Figure 15 and Figure 16. From the front of the motorcycle looking at the back of the gauges, the power terminal post (+) will be at 9:00 o'clock (1), the negative terminal post (-) will be at 12:00 o'clock (noon) (2) and the signal terminal post (S) will be at 3:00 o'clock (3).

Items 8, 10, 11, and 12 will not be used with 2007 and later models.

- c. Yellow (signal) to signal (S) terminal.
8. Install nut to secure ring terminal over posts and nuts on back of gauge.
9. Verify ring terminals or wires are not grounding against each other.
10. Push gauge housing into isolation gasket and install flat head screw from gauge housing kit.
11. Tighten flat head screw to snug the housing up against the gasket.
12. Inspect the seal of isolation gasket around the perimeter of housing.

## Inspect Wiring

1. With the wire harness along frame and to the gauge, bounce motorcycle to look for pinch points between suspension components and gauge wires.
2. Cable wrap the gauge harness wires together at the back of the gauge housings.
3. To look for pinch points in the steering, turn front forks lock to lock.
4. Verify absence of pinch points or clearance from heat sources along wiring harness.

## Return Motorcycle to Service

1. **2004-later models except XL:** Install fuse block.
2. Replace fuel tank, attach fuel line or fittings, and add fuel following the instructions in the Service Manual.

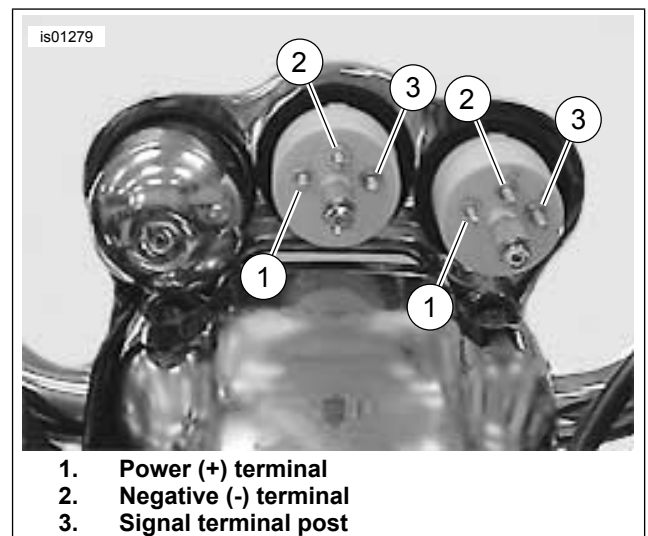

**Figure 15. Gauge Cluster, Back (XL Custom)**



**Figure 16. Gauge Cluster, Front (XL Custom)**

3. Connect negative (-) battery cable to the battery.

**▲ WARNING**

After installing seat, pull upward on seat to be sure it is locked in position. While riding, a loose seat can shift causing loss of control, which could result in death or serious injury. (00070b)

4. Install seat and side covers.
5. Align headlamp according to the instructions in the Service Manual.

**Test Installation**

1. To test oil temperature gauge, turn ignition to ON. Gauge should illuminate and read ambient temperature or remain pegged at the lowest graduation.
2. Start engine. With engine running, oil temperature should rise as engine warms and should read approximately 230° F at operating temperature.

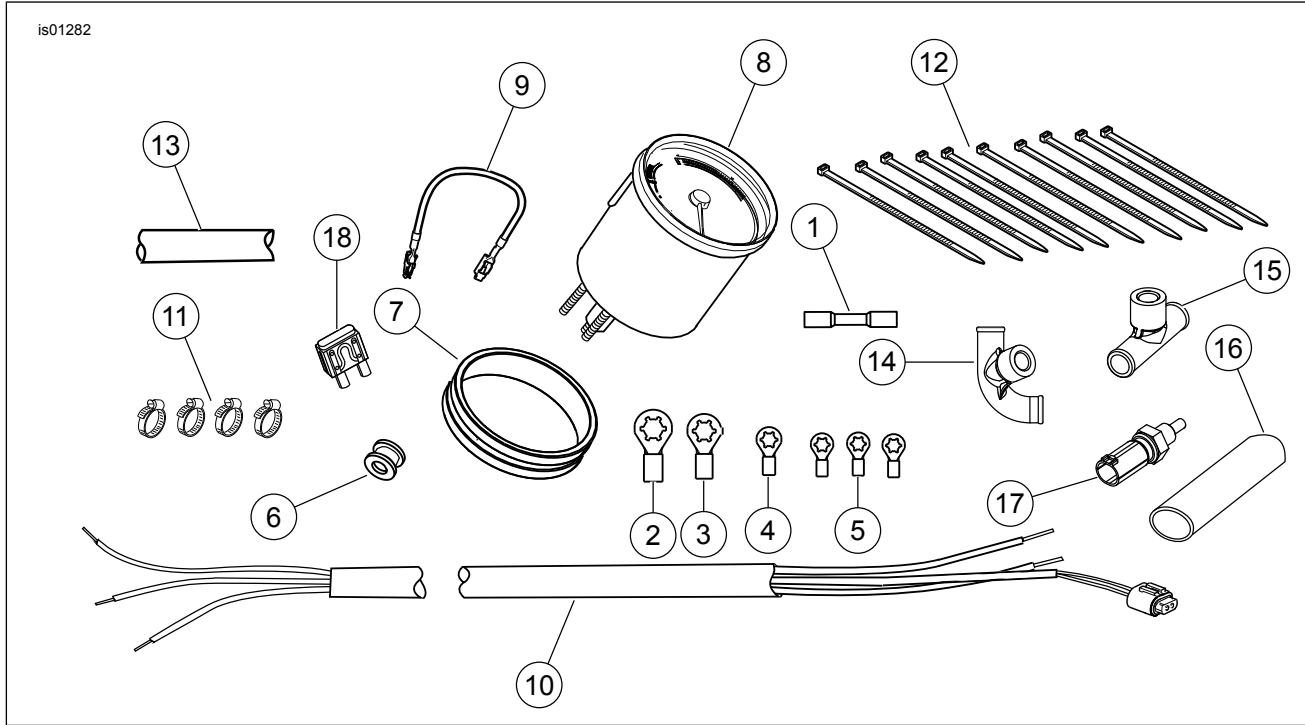
**SERVICE PARTS**

Figure 17. Service Parts: One and One-Half Inch Oil Temperature Gauge Kit

Table 1. Service Parts: One and One-Half Inch Oil Temperature Gauge Kit

Item	Description (Quantity)	Part Number
1	Butt splice, 14-16 gauge	70586-93
2	Ring terminal, 5/16 inch	9859
3	Ring terminal, 1/4 inch	9858
4	Ring terminal, #10	9857
5	Ring terminal, #6 (3)	9856
6	Grommet	11431
7	Isolation gasket	75260-04
8	Oil Temperature gauge	Not Sold Separately
9	Fuse block adapter	70329-04
10	Wiring harness	Not Sold Separately
11	Worm gear clamp #8 (4)	9969
12	Cable strap	10006
13	Oil supply hose	63611-00
14	90 degree fitting	26409-04
15	T-fitting	26407-04
16	High temperature conduit	47590ZZ
17	Sending unit	72357-04
18	Fuse, 2 Amp	54305-96